

MODEL 3HP | INSTRUMENTATION SERIES

3-WAY THREADED STANDARD PORT BALL VALVES

Flow-Tek's Instrumentation Series 3-Way ball valves offer rugged reliability for high pressure and instrumentation applications. The valves feature three piece bodies designed for flexibility of installation and ease of maintenance. Model 3HP is constructed as standard with 316 stainless steel bodies manufactured to NACE specifications. Other body materials are available such as Duplex SS, Hastelloy, Monel and Titanium. All bodies are marked with a heat code for full material traceability.

A floating ball design provides a positive, bubble tight shut off with smooth quarter turn operation at low operating

torque. Additional advantages of the Instrumentation Series include a choice of lever or pointer handles, travel limit stop pins and replaceable seats and seals. Locking kits which secure the valve in a desired position are also available.

Safety features include an internally loaded blow-out proof stem and end connections that are pinned to prevent inadvertent loosening or disassembly.

Pressure Rating	End Connections
5,000 psi	Standard: NPT Optional: Compression Fittings

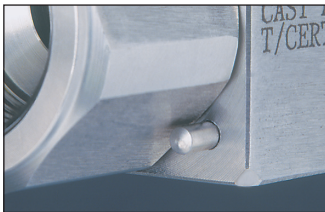

Pinned End Connections

Actuator Mounting: Valves with actuator mounting to ISO 5211 specifications and live loading are also available as an option.

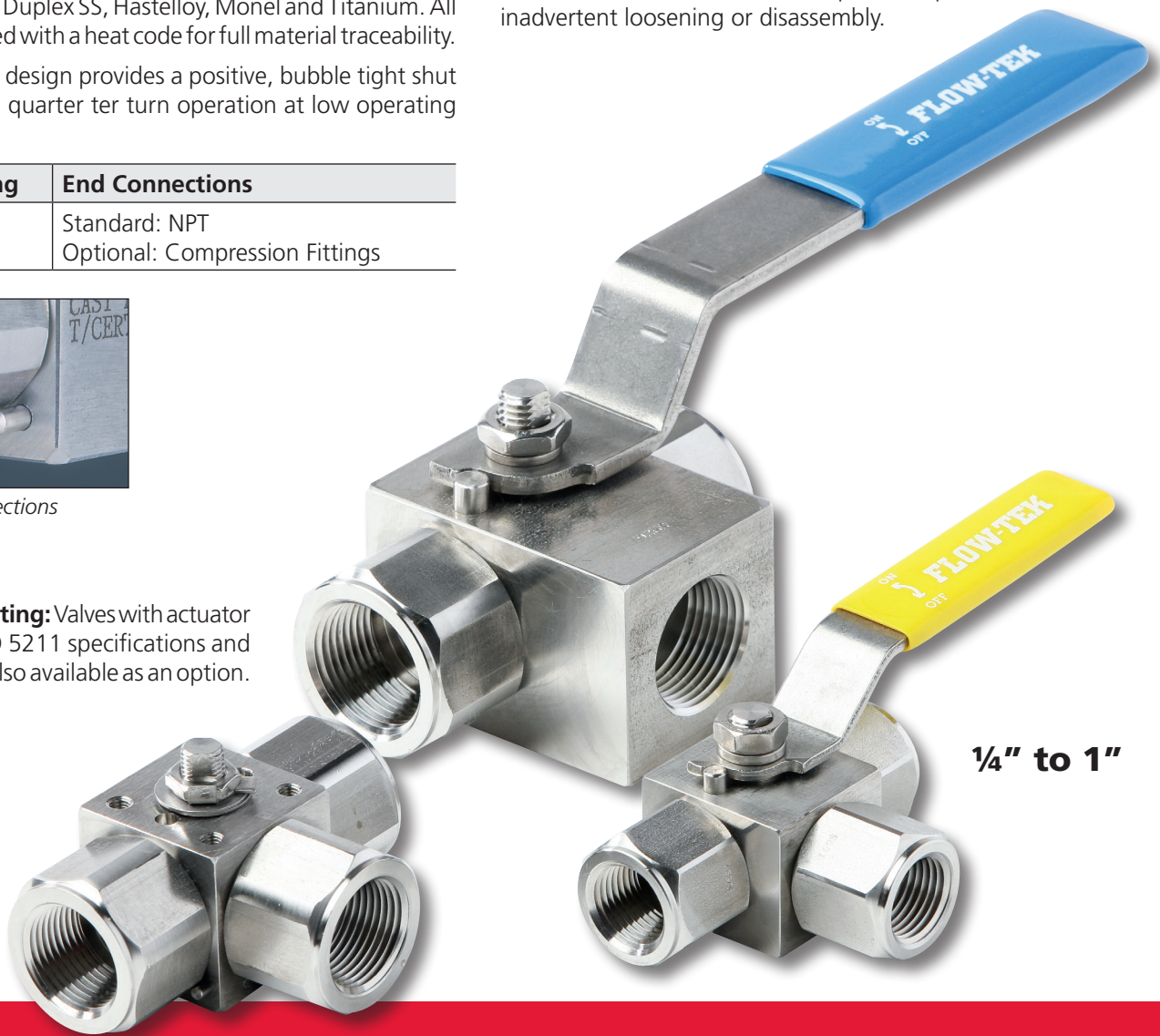

1/4" to 1"

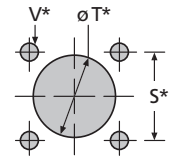
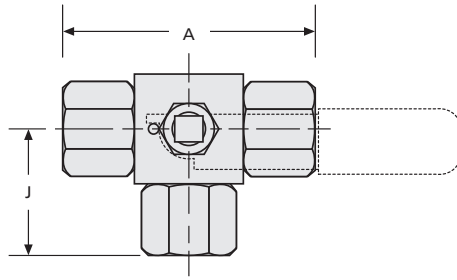
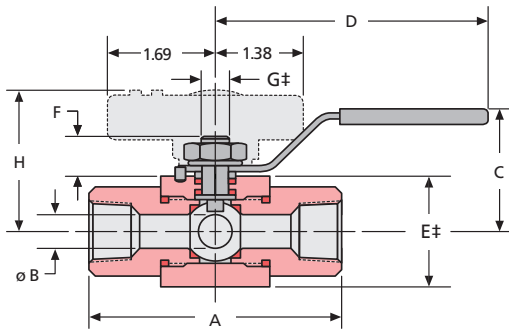

For Optional Panel Mounting:
Verify the mounting dimensions before manufacturing mounting hardware.

Dimensions

Size ins. mm	A	ØB	C	D	E [‡]	F	G [‡]	H	J	S [*]	ØT [*]	V [*]	Torque in. lbs. mm	Weight lbs. kg
1/4 8	2.79 71	0.39 10	1.77 45	4.52 115	1.26 32	0.63 16	0.33 8.5	1.92 49	1.40 35.6	1.02 26	1.18 30	M4x0.236 M4x6mm	150 17	1.1 0.5
3/8 10	3.03 77	0.39 10	1.77 45	4.52 115	1.26 32	0.63 16	0.33 8.5	1.92 49	1.30 33	1.02 26	1.18 30	M4x0.236 M4x6mm	150 17	1.2 0.5
1/2 15	3.34 85	0.39 10	1.77 45	4.52 115	1.26 32	0.63 16	0.33 8.5	1.92 49	1.60 40.6	1.02 26	1.18 30	M4x0.236 M4x6mm	150 17	1.3 0.6
3/4 20	3.54 90	0.50 12.7	1.96 50	4.52 115	1.49 38	0.59 15	0.33 8.5	2.04 52	1.80 45.7	1.02 26	1.18 30	M4x0.236 M4x6mm	220 25	1.8 0.8
1 25	4.37 111	0.78 20	2.36 60	6.49 165	1.96 50	1.06 27	0.49 12.5	—	1.50 38	1.57 40	1.57 40	M5x0.315 M5x8mm	300 34	3.8 1.7

Ø Indicates round dimensions. ‡Indicates square dimensions. *Option for actuator ready version to be specified when ordering.
A 2-Way version of the Model 3HP valve is also available. Please see Flow-Tek brochure HP/HX.

C_v Model 3HP

Size ins mm	1/4 8	3/8 10	1/2 15	3/4 20	1 25
L-Port	5.3	5.3	5.3	8.6	21

Flow Pattern

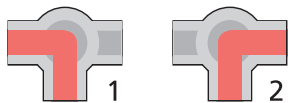

Standard Side Entry
Flow Diversion

Pressure / Temperature

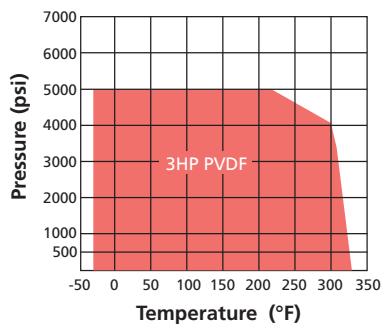

Components & Materials

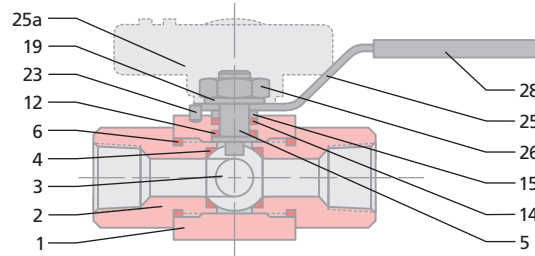

Item	Name	Material	Qty.
1	Body	Stainless Steel 316	1
2	End Connector	Stainless Steel 316	2
3	Ball	Stainless Steel 316	1
4	Seat*	PVDF	2
5	Stem	Stainless Steel 316	1
6	Body Seal*	RPTFE	2
12	Thrust Washer*	RPTFE	1
14	Stem Packing*	RPTFE	1
15	Packing Gland	Stainless Steel	1
19	Lock Washer	Stainless Steel	2
23	Stop Pin	Stainless Steel	1
25	Lever Handle	Stainless Steel	1
25a	Pointer Handle	Mazak 3	1
26	Lock Nut	Stainless Steel	1
28	Handle Sleeve	Vinyl	1

*Parts included in the repair kits.

Other body and seat materials are also available.
Please contact your Flow-Tek representative for options.

Flow-Tek
Subsidiary of BRAY INTERNATIONAL, Inc.

8323 N. Eldridge Pkwy. #100
Houston, Texas 77041
Tel: 832.912.2300
Fax: 832.912.2301
bray.com/flow-tek

All statements, technical information, and recommendations in this bulletin are for general use only. Consult Flow-Tek representatives or factory for the specific requirements and material selection for your intended application. The right to change or modify product design or product without prior notice is reserved.

Flow-Tek® is a registered trademark of Bray International, Inc.

© 2018 Bray International | All rights reserved. | F-2501_3HP_EN_01_2018